

DELPHI SERIES



FEATURES

- ♦ High efficiency: 95.0% @ 20Vin, 15.0V/3A
- ♦ Small size and low profile:
17.8x15.0x7.8mm (0.70"x0.59"x0.31")
- ♦ Output voltage adjustment: 8.0V~15.0V
- ♦ Monotonic startup into normal and pre-biased loads
- ♦ Input UVLO, output OCP
- ♦ Remote ON/OFF
- ♦ Output short circuit protection
- ♦ Fixed frequency operation
- ♦ Copper pad to provide excellent thermal performance
- ♦ ISO 9001, TL 9000, ISO 14001, QS9000, OHSAS18001 certified manufacturing facility
- ♦ UL/cUL 60950 (US & Canada) Recognized, and TUV (EN60950) Certified
- ♦ CE mark meets 73/23/EEC and 93/68/EEC directives

Delphi Series IPM24S0C0, Non-Isolated, Integrated Point-of-Load Power Modules: 20V~36V input, 8.0~15.0V and 3A Output

The Delphi Series IPM24S0C0 non-isolated, fully integrated Point-of-Load (POL) power modules, are the latest offerings from a world leader in power systems technology and manufacturing — Delta Electronics, Inc. This product family provides up to 3A of output current or 45W of output power in an industry standard, compact, IC-like, molded package. It is highly integrated and does not require external components to provide the point-of-load function. A copper pad on the back of the module; in close contact with the internal heat dissipation components; provides excellent thermal performance. The assembly process of the modules is fully automated with no manual assembly involved. These converters possess outstanding electrical and thermal performance, as well as extremely high reliability under highly stressful operating conditions. IPM24S0C0 operates from a 20V~36V source and provides a programmable output voltage from 8.0V to 15.0V. The IPM product family is available in either a SMD or SIP package. IPM24S family is also available for output 1.2V~2.5V or 3.3V~6.5V. Please refer to IPM24S0A0 and IPM24S0B0 datasheets for details.

OPTIONS

- ♦ SMD or SIP package

APPLICATIONS

- ♦ Telecom/DataCom
- ♦ Wireless Networks
- ♦ Optical Network Equipment
- ♦ Server and Data Storage
- ♦ Industrial/Test Equipment

TECHNICAL SPECIFICATIONS

T_A = 25°C, airflow rate = 300 LFM, V_{in} = 24Vdc, nominal V_{out} unless otherwise noted.

PARAMETER	NOTES and CONDITIONS	IPM24S0C0R/S03FA			
		Min.	Typ.	Max.	Units
ABSOLUTE MAXIMUM RATINGS					
Input Voltage (Continuous)		0		40	Vdc
Operating Temperature	Please refer to Fig.32 for the measuring point	-40		125	°C
Storage Temperature		-55		125	°C
INPUT CHARACTERISTICS					
Operating Input Voltage		20		36	V
Input Under-Voltage Lockout					
Turn-On Voltage Threshold			19.3		V
Turn-Off Voltage Threshold			18.8		V
Maximum Input Current	V _{in} =V _{in,min} to V _{in,max} , I _o =I _{o,max}				A
No-Load Input Current			50		mA
Off Converter Input Current			3	10	mA
Input Reflected-Ripple Current	P-P 0.5μH inductor, 5Hz to 20MHz		60	150	mAp-p
Input Voltage Ripple Rejection	120 Hz		TBD		dB
OUTPUT CHARACTERISTICS					
Output Voltage Set Point	V _{in} =24V, I _o =I _{o,max} , T _a =25°C	7.88	8.0	8.12	Vdc
Output Voltage Adjustable Range		8.0		15.0	V
Output Voltage Regulation					
Over Line	V _{in} =V _{in,min} to V _{in,max}		0.3		% V _{o,set}
Over Load	I _o =I _{o,min} to I _{o,max}		0.3		% V _{o,set}
Over Temperature	T _a =T _{a,min} to T _{a,max}		0.01	0.025	%V _{o,set} /°C
Total Output Voltage Range	Over sample load, line and temperature	-3.0		+3.0	% V _{o,set}
Output Voltage Ripple and Noise					
Peak-to-Peak	5Hz to 20MHz bandwidth				
RMS	Full Load, 1μF ceramic, 100μF OS-conx2		50	100	mVp-p
RMS	Full Load, 1μF ceramic, 100μF OS-conpx2		25	50	mV
Output Current Range	V _o >8.0Vdc	0		3	A
Output Voltage Over-shoot at Start-up	V _{in} =20V to 36V, I _o =0A to 3A, T _a =25°C		0	1	% V _{o,set}
Output DC Current-Limit Inception			130		% I _o
DYNAMIC CHARACTERISTICS					
Dynamic Load Response					
Positive Step Change in Output Current	100μFX2 OS-CON & 1μF Ceramic load cap, 0.5A/μs				
Negative Step Change in Output Current	50% I _{o,max} to 100% I _{o,max}		75	200	mVpk
Setting Time to 10% of Peak Deviation	100% I _{o,max} to 50% I _{o,max}		75	200	mVpk
Turn-On Transient	I _o =I _{o,max}		200	300	μs
Start-Up Time, From On/Off Control			17	50	ms
Start-Up Time, From Input			17	50	ms
Output Voltage Rise Time	Time for V _o to rise from 10% to 90% of V _{o,set} ,	5	9	17	ms
Maximum Output Startup Capacitive Load	Full load; ESR ≥ 15mΩ			200	μF
	Full load; ESR ≥ 12mΩ			1200	μF
EFFICIENCY					
V _o =8.0V	V _{in} =24V, I _o =I _{o,max} , T _a =25°C	89.0	91.0		%
V _o =15.0V	V _{in} =24V, I _o =I _{o,max} , T _a =25°C	91.5	93.5		%
FEATURE CHARACTERISTICS					
Switching Frequency					
			300		kHz
ON/OFF Control, (Logic High-Module ON)					
Logic High	Module On	2.4		V _{in,max}	V
Logic Low	Module Off	-0.2		0.8	V
ON/OFF Current	I _{on/off} at V _{on/off} =0		0.25	1	mA
Leakage Current	Logic High, V _{on/off} =5V			50	μA
GENERAL SPECIFICATIONS					
Calculated MTBF	I _o =80% I _{o,max} , T _a =25°C		13.04		M hours
Weight			6		grams



ELECTRICAL CHARACTERISTICS CURVES

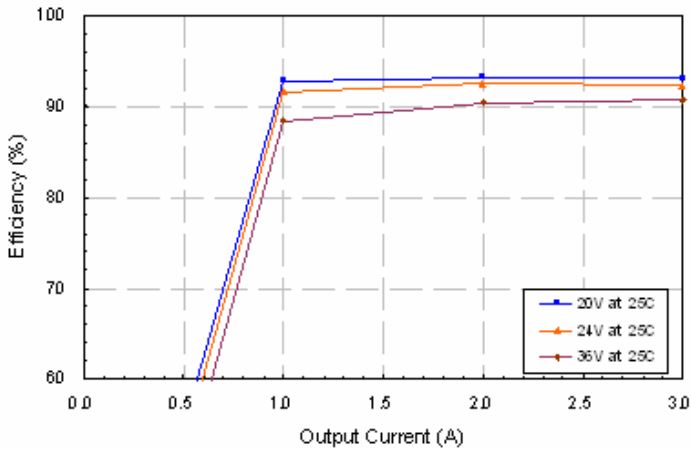

Figure 1: Converter efficiency vs. output current (8.0V output voltage)

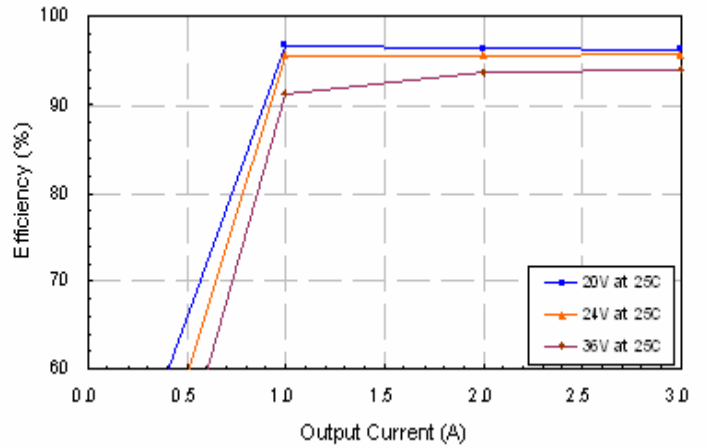

Figure 2: Converter efficiency vs. output current (15.0V output voltage)

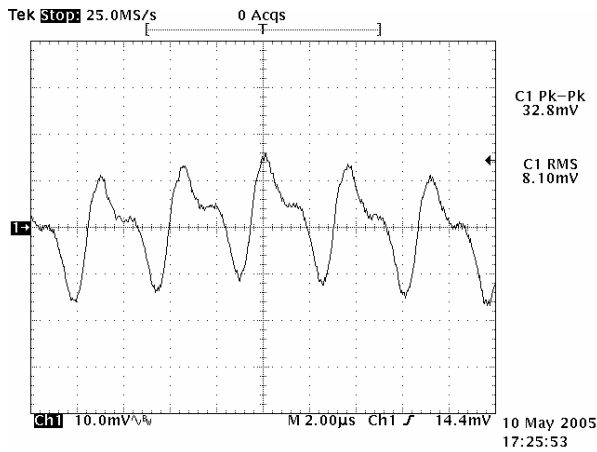

Figure 3: Output ripple & noise at 36Vin, 8.0V/3A out

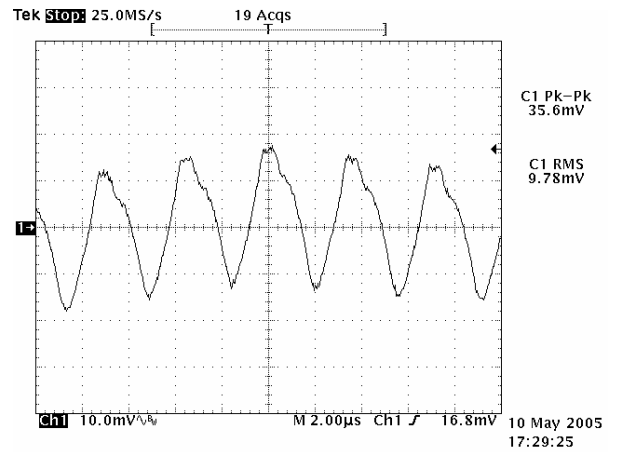

Figure 4: Output ripple & noise at 36Vin, 15.0V/3A out

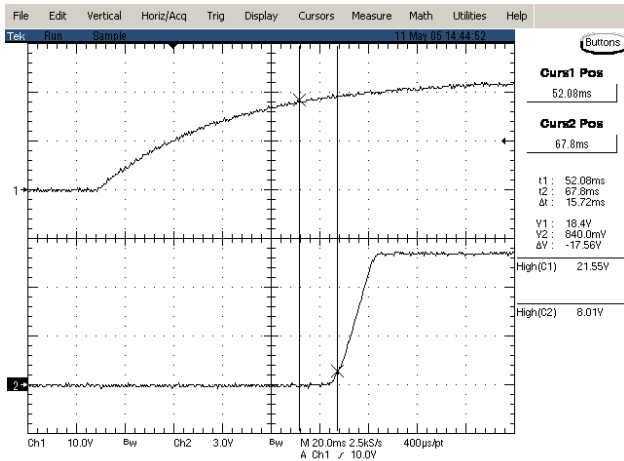

Figure 5: Power on waveform at 24vin, 8.0V/3A out with application of Vin

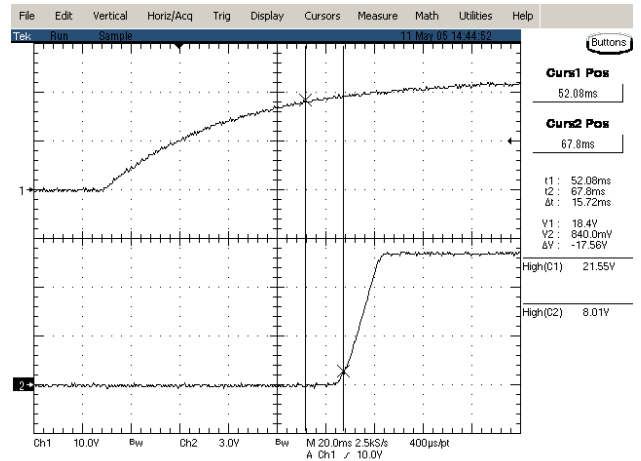

Figure 6: Power on waveform at 24vin, 8.0V/3A out with application of Vin

ELECTRICAL CHARACTERISTICS CURVES

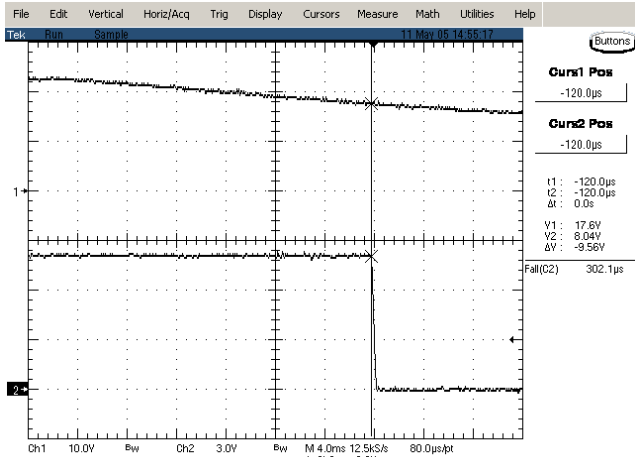

Figure 7: Power off waveform at 24vin, 8.0V/3A out with application of Vin

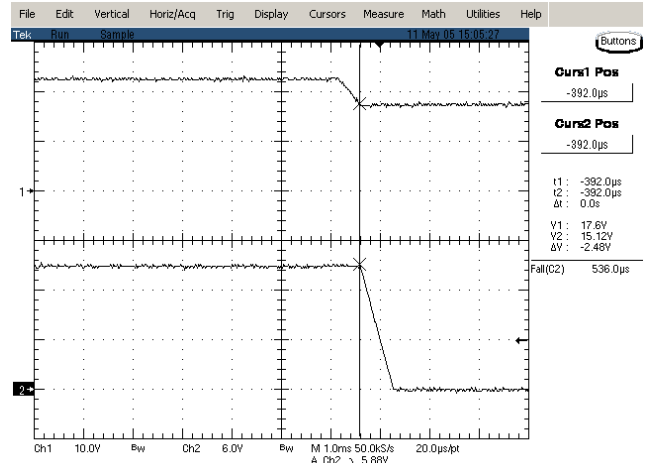

Figure 8: Power off waveform 24vin, 15.0V/3A out with application of Vin

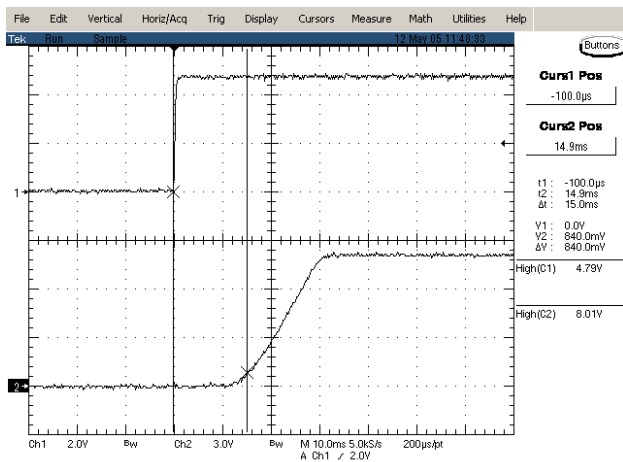

Figure 9: Remote turn on delay time at 24vin, 8.0V/3A out

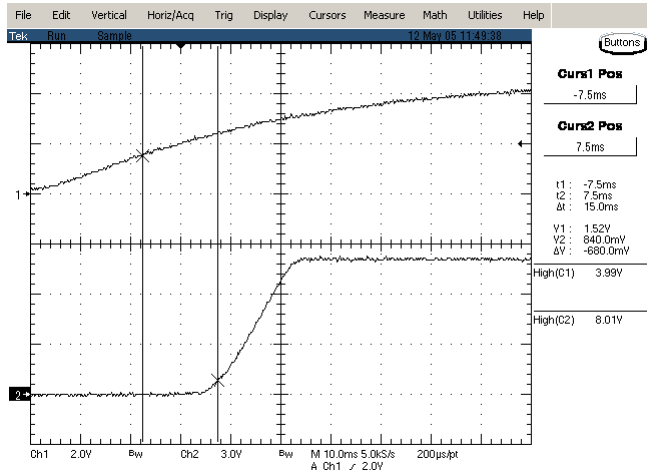

Figure 10: Remote turn on delay time at 24vin, 8.0V/3A out

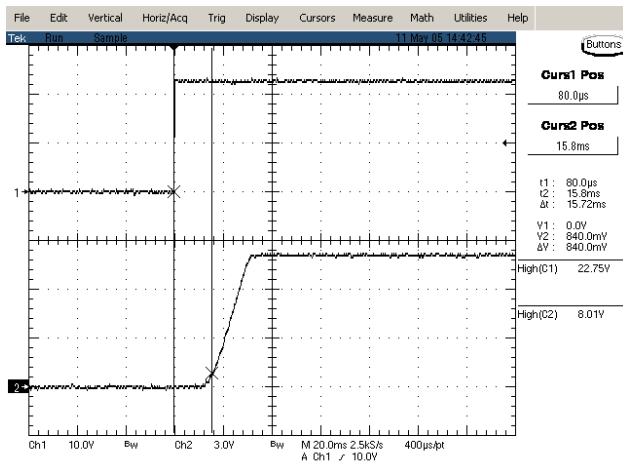

Figure 11: Turn on delay at 24vin, 8.0V/3A out with application of Vin

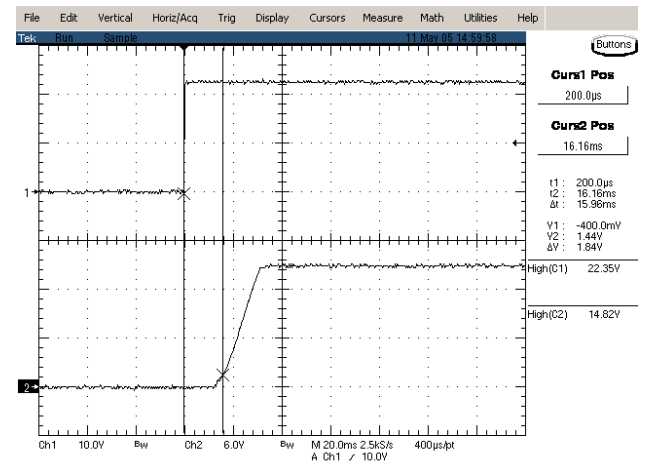

Figure 12: Turn on delay at 24vin, 15.0V/3A out with application of Vin

ELECTRICAL CHARACTERISTICS CURVES

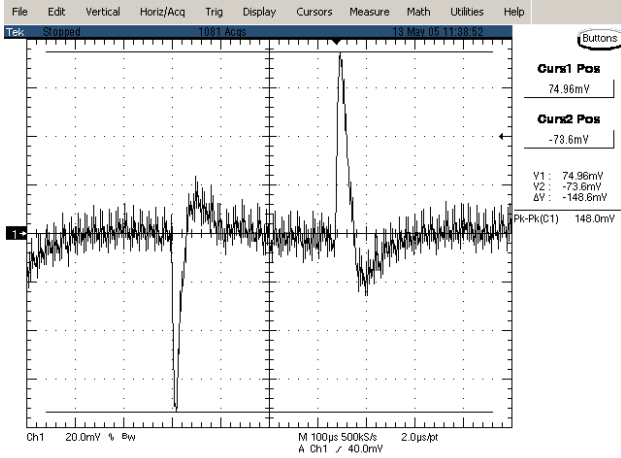

Figure 13: Typical transient response to step load change at $0.5A/\mu S$ from 100% to 50% of I_o , max at 24Vin, 15.0V out (measurement with a 1uF ceramic)

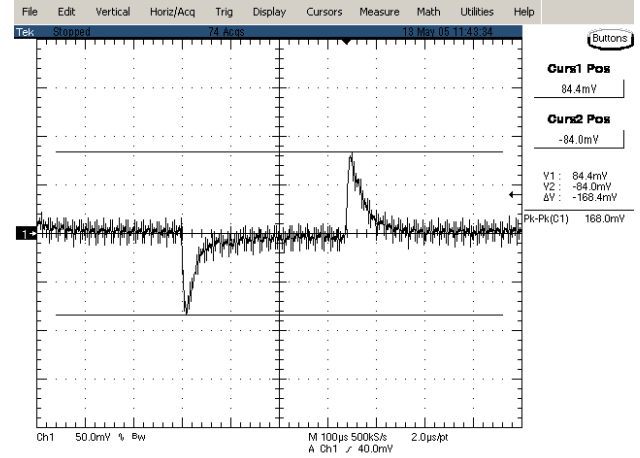
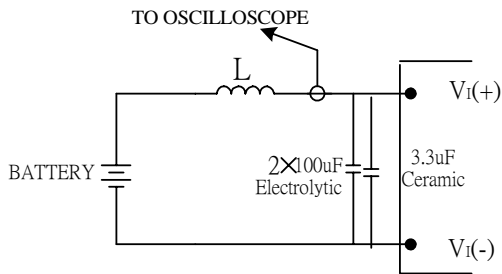

Figure 14: Typical transient response to step load change at $0.5A/\mu S$ from 50% to 100% of I_o , max at 36Vin, 6.5V out (measurement with a 1uF ceramic)

TEST CONFIGURATIONS



Note: Input reflected-ripple current is measured with a simulated source inductance. Current is measured at the input of the module.

Figure 15: Input reflected-ripple current test setup

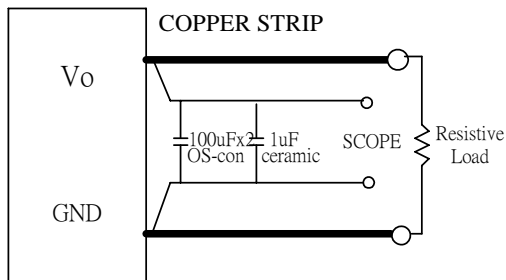

Note: Use a 100 μ Fx2 OS-son and 1 μ F capacitor. Scope measurement should be made using a BNC connector.

Figure 16: Peak-peak output noise and startup transient measurement test setup

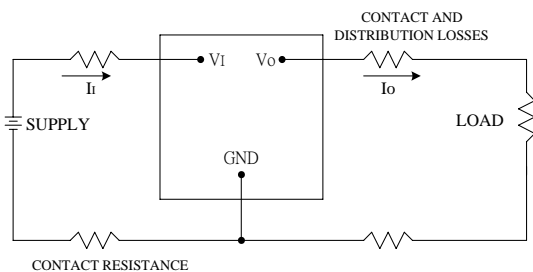

Figure 17: Output voltage and efficiency measurement test setup

Note: All measurements are taken at the module terminals. When the module is not soldered (via socket), place Kelvin connections at module terminals to avoid measurement errors due to contact resistance.

$$\eta = \left(\frac{V_o \times I_o}{V_i \times I_i} \right) \times 100 \%$$

DS_IPM24S0C0_01092009

DESIGN CONSIDERATIONS

Input Source Impedance

To maintain low-noise and ripple at the input voltage, it is critical to use low ESR capacitors at the input to the module. Figure 26 shows the input ripple voltage (mVp-p) for various output models using 2x100 μ F low ESR electrolytic capacitors (Rubycon P/N:50YXG100, 100 μ F/50V or equivalent) and 1x3.3.0 μ F very low ESR ceramic capacitors (TDK P/N: C4532JB1H335M, 3.3 μ F/50V or equivalent).

The input capacitance should be able to handle an AC ripple current of at least:

$$I_{rms} = I_{out} \sqrt{\frac{V_{out}}{V_{in}} \left(1 - \frac{V_{out}}{V_{in}} \right)} \quad A_{rms}$$

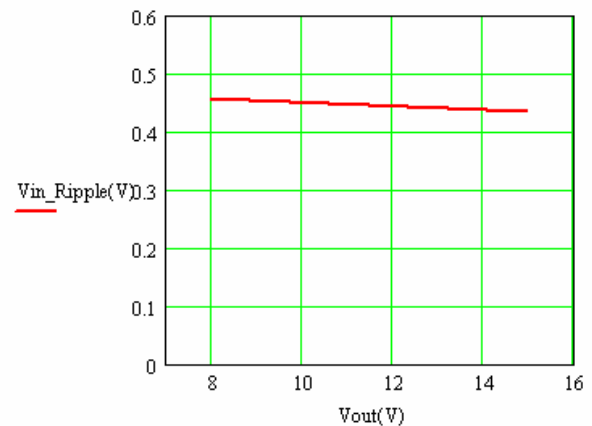

Figure 18: Input ripple voltage for various output models, $I_o = 3A$ ($C_{in} = 2 \times 100\mu F$ electrolytic capacitors 1x3.3 μF ceramic capacitors at the input)

The power module should be connected to a low ac-impedance input source. Highly inductive source impedances can affect the stability of the module. An input capacitance must be placed close to the modules input pins to filter ripple current and ensure module stability in the presence of inductive traces that supply the input voltage to the module.

DESIGN CONSIDERATIONS

Remote On/Off

The IPM series power modules have an On/Off control pin for output voltage remote On/Off operation. The On/Off pin is an open collector/drain logic input signal that is referenced to ground. When On/Off control pin is not used, leave the pin unconnected.

The remote on/off pin is internally connected to +5Vdc through an internal pull-up resistor. Figure 27 shows the circuit configuration for applying the remote on/off pin. The module will execute a soft start ON when the transistor Q1 is in the off state.

The typical rise for this remote on/off pin at the output voltage of 2.5V and 5.0V are shown in Figure 17 and 18.

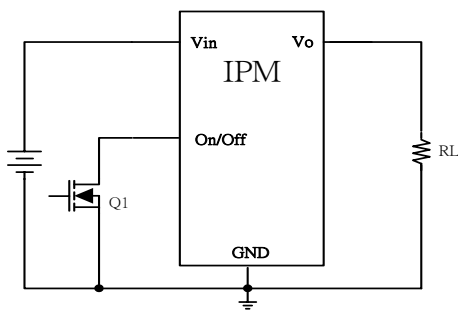

Figure 19: Remote on/off implementation

FEATURES DESCRIPTIONS

Over-Current Protection

To provide protection in an output over load fault condition, the unit is equipped with internal over-current protection. When the over-current protection is triggered, the unit enters hiccup mode. The units operate normally once the fault condition is removed.

Output Voltage Programming

The output voltage shall be externally adjustable by use of a Trim pin. The module output shall be adjusted by either a voltage source referenced to ground or an external resistor be connected between trim pin and Vo or ground. To trim-down using an external resistor, connect a resistor between the Trim and Vo pin of the module. To trim up using an external resistor, connect the resistor between the Trim and ground pins of the module. The value of resistor is defined below. The module outputs shall not be adversely affected (regulation and operation) when the Trim pin is left open.

IPM can also be programmed by applying a voltage between the TRIM and GND pins (Figure 20). The following equation can be used to determine the value of Vtrim needed for a desired output voltage Vadj:

Trim up

$$R_{\text{trim}} = \frac{(V_{\text{out}} - 0.7) * 1.91}{V_{\text{adj}} - V_{\text{out}}} \quad (\text{K}\Omega)$$

Trim Down

$$R_{\text{trim}} = \frac{(V_{\text{adj}} - 0.7) * 20}{V_{\text{out}} - V_{\text{adj}}} \quad (\text{K}\Omega)$$

Rtrim is the external resistor in KΩ
Vadj is the desired output voltage

FEATURES DESCRIPTIONS (CON.)

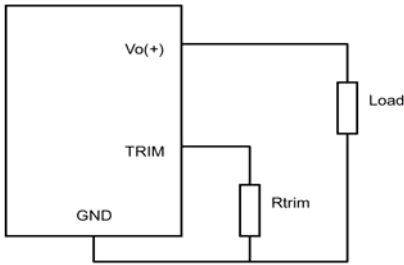

Figure 20: Trim up Circuit configuration for programming output voltage using an external resistor

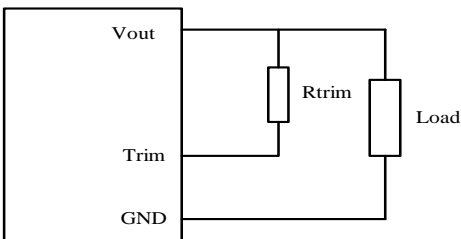

Figure 21: Trim down Circuit configuration for programming output voltage using an external resistor

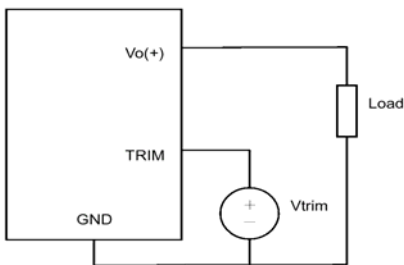

Figure 22: Circuit configuration for programming output voltage using external voltage source

Table 1 provides Rtrim values required for some common output voltages. By using a 0.5% tolerance resistor, set point tolerance of $\pm 2\%$ can be achieved as specified in the electrical specification.

Table 1 Rtrim is the external resistor in K Ω ; Vout is the desired output voltage

		Rtrim setting (Ω)		Output Measurement
		R.trim_Up	R.trim_Down	0A
Vo	8.0	NC	NC	V
Vadj	15.0	2K	NC	V
Vadj	$8.0 \cdot (1-10\%)$	NC	215K	V

The amount of power delivered by the module is the voltage at the output terminals multiplied by the output current. When using the trim feature, the output voltage of the module can be increased, which at the same output current would increase the power output of the module. Care should be taken to ensure that the maximum output power of the module must not exceed the maximum rated power ($V_{o.set} \times I_{o.max} \leq P_{max}$).

Voltage Margining

Output voltage margining can be implemented in the IPM modules by connecting a resistor, $R_{margin-up}$, from the Trim pin to the ground pin for margining-up the output voltage and by connecting a resistor, $R_{margin-down}$, from the Trim pin to the output pin for margining-down. Figure 32 shows the circuit configuration for output voltage margining. If unused, leave the trim pin unconnected.

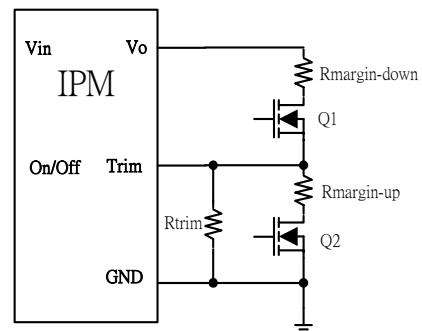

Figure 23: Circuit configuration for output voltage margining

THERMAL CONSIDERATIONS

Thermal management is an important part of the system design. To ensure proper, reliable operation, sufficient cooling of the power module is needed over the entire temperature range of the module. Convection cooling is usually the dominant mode of heat transfer.

Hence, the choice of equipment to characterize the thermal performance of the power module is a wind tunnel.

Thermal Testing Setup

Delta's DC/DC power modules are characterized in heated vertical wind tunnels that simulate the thermal environments encountered in most electronics equipment. This type of equipment commonly uses vertically mounted circuit cards in cabinet racks in which the power modules are mounted.

The following figure shows the wind tunnel characterization setup. The power module is mounted on a test PWB and is vertically positioned within the wind tunnel. The height of this fan duct is constantly kept at 25.4mm (1").

Thermal Derating

Heat can be removed by increasing airflow over the module. To enhance system reliability, the power module should always be operated below the maximum operating temperature. If the temperature exceeds the maximum module temperature, reliability of the unit may be affected.

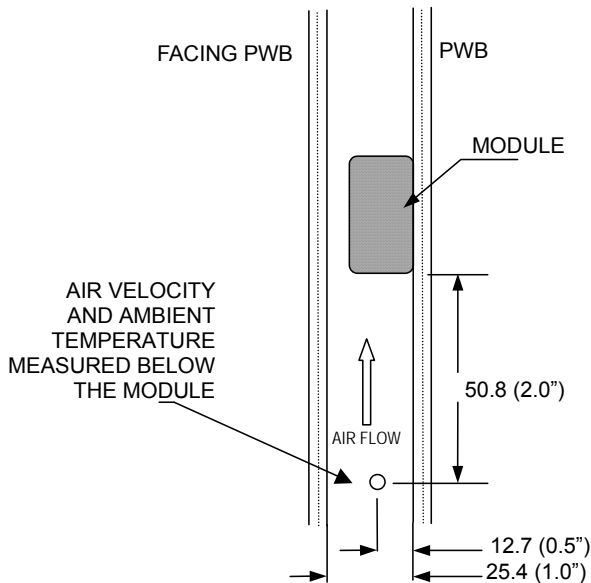

Note: Figure dimensions are in millimeters and (inches)
Figure 24: Wind tunnel test setup

THERMAL CURVES

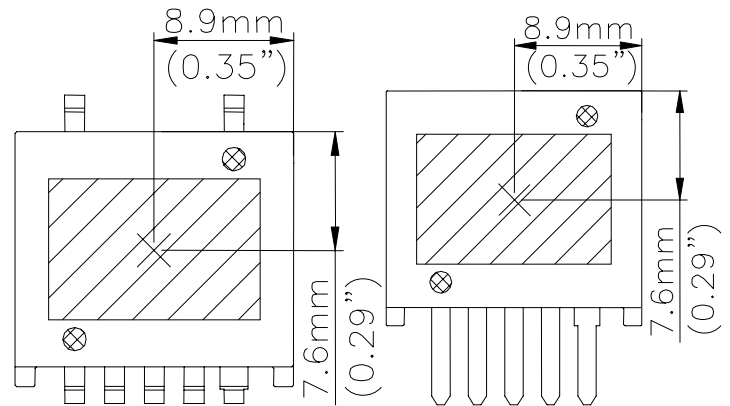

Figure 25: Temperature measurement location

* The allowed maximum hot spot temperature is defined at 125 °C.

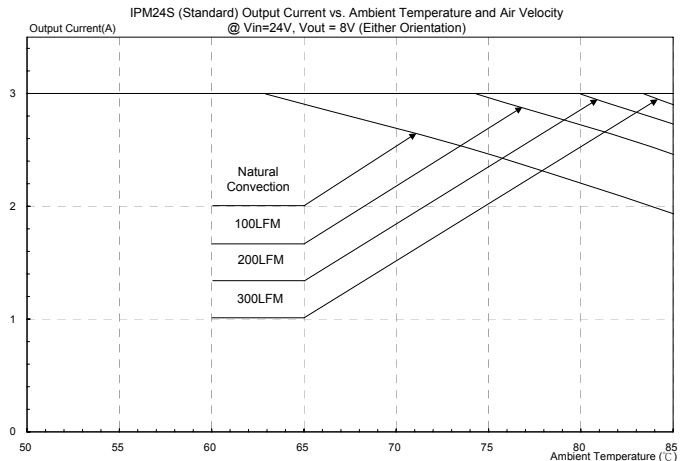

Figure 26: Output current vs. ambient temperature and air velocity
 @ Vin=24V, Vout=8V(Either Orientation)

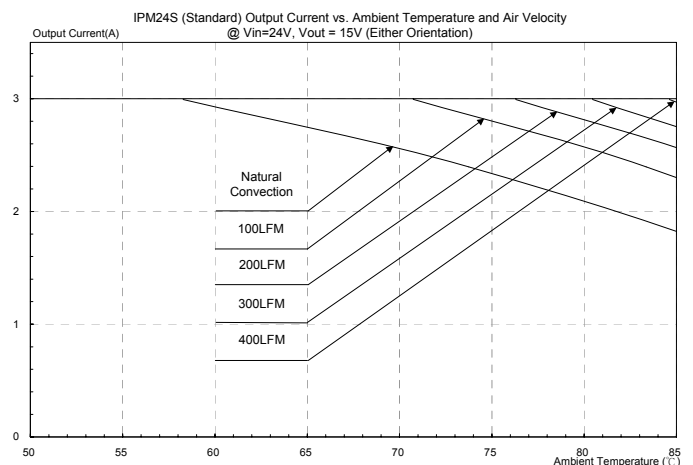
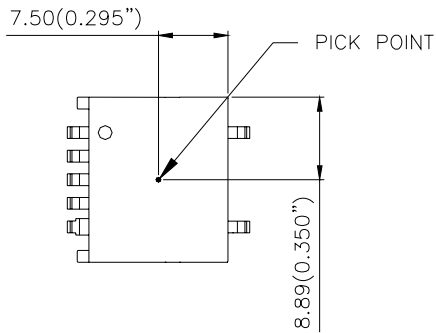

Figure 27: Output current vs. ambient temperature and air velocity
 @ Vin=24V, Vo=15V(Either Orientation)



PICK AND PLACE LOCATION



All dimensions are in millimeters (inches)

SURFACE- MOUNT TAPE & REEL

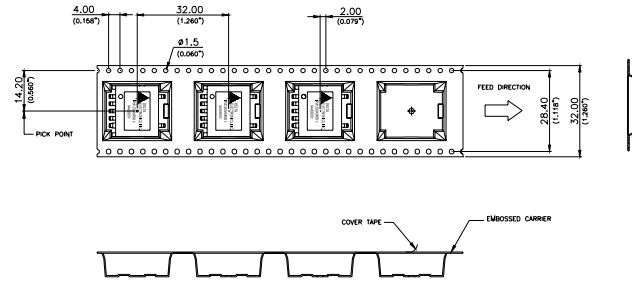

All dimensions are in millimeters (inches)

LEAD FREE PROCESS RECOMMEND TEMP. PROFILE

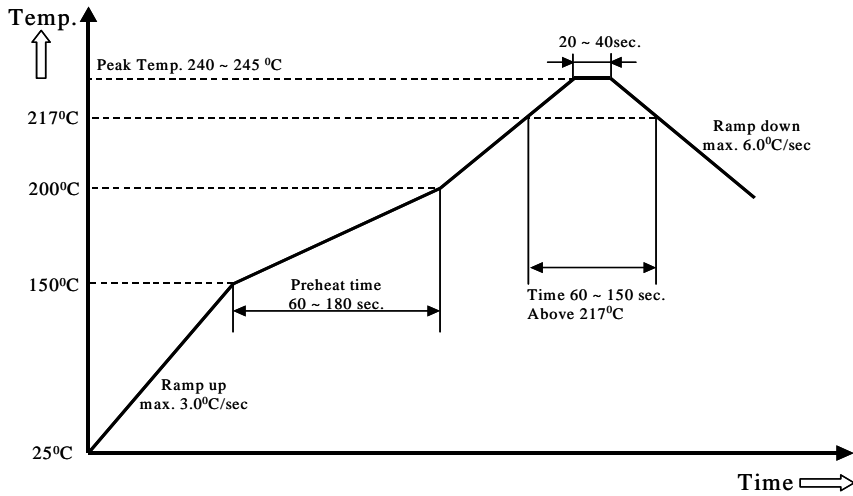

Note: All temperature refers to topside of the package, measured on the package body surface.

Mechanical Drawing

SMD PACKAGE

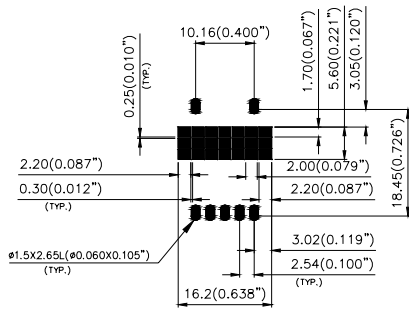
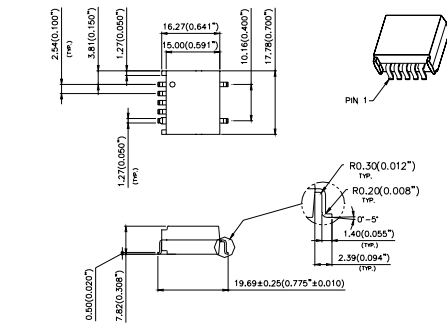

RECOMMEND PWB PAD LAYOUT

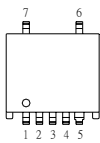

Pin#	Function
1	Remote on/off
2	+Vin
3	Ground
4	+Vo
5	Trim
6	No connection
7	No connection

SIP PACKAGE

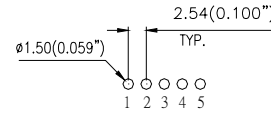
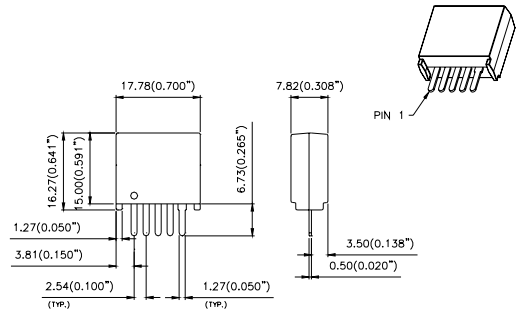

RECOMMEND PWB HOLE LAYOUT

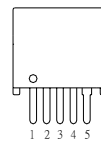

Pin#	Function
1	Remote on/off
2	+Vin
3	Ground
4	+Vo
5	Trim

Note: The copper pad is recommended to connect to the ground.

ALL DIMENSION ARE IN MILLIMETERS (INCHES)
STANDARD DIMENSION TOLERANCE IS $\pm 0.10(0.004")$

PART NUMBERING SYSTEM

IPM	24	S	0C0	S	03	F	A
Product Family	Input Voltage	Number of Outputs	Output Voltage	Package	Output Current		Option Code
Integrated POL Module	24 -20V ~ 36V	S - Single	0C0 - programmable output 8.0V~15.0V	R - SIP S - SMD	03 - 3A	F- RoHS 6/6 (Lead Free)	A - Standard Function

MODEL LIST

Model Name	Input Voltage	Output Voltage	Output Current	Efficiency (Full load@12Vin)
IPM24S0A0S/R03FA	8V ~ 36V	1.2V ~ 2.5V	3A	85%
IPM24S0B0S/R03FA	11V ~ 36V	3.3V ~ 6.5V	3A	91%
Model Name	Input Voltage	Output Voltage	Output Current	Efficiency (Full load@20Vin)
IPM24S0C0S/R03FA	20V ~ 36V	8.0V~15.0V	3A	95%

CONTACT: www.delta.com.tw/dcdc

USA:

Telephone:
East Coast: (888) 335 8201
West Coast: (888) 335 8208
Fax: (978) 656 3964
Email: DCDC@delta-corp.com

Europe:

Telephone: +41 31 998 53 11
Fax: +41 31 998 53 53
Email: DCDC@delta-es.com

Asia & the rest of world:

Telephone: +886 3 4526107
Ext 6220~6224
Fax: +886 3 4513485
Email: DCDC@delta.com.tw

WARRANTY

Delta offers a two (2) year limited warranty. Complete warranty information is listed on our web site or is available upon request from Delta.

Information furnished by Delta is believed to be accurate and reliable. However, no responsibility is assumed by Delta for its use, nor for any infringements of patents or other rights of third parties, which may result from its use. No license is granted by implication or otherwise under any patent or patent rights of Delta. Delta reserves the right to revise these specifications at any time, without notice.